

616 GSR Stone Set “D”

Installation Instructions (SKU 94700728)

Warnings



Do not use crushed glass media with this log set. It causes excess sooting. Use included rock wool.



Make sure the gas control valve is OFF and the heater is cool prior to conducting service.



Failure to position the parts in accordance with these diagrams or failure to use only parts specifically approved with this appliance may result in property damage or personal injury.



Consult the owner’s manual for proper exhaust restrictor and air shutter positions.



If using propane (LP), convert the appliance before installing the stones (see the owner’s manual for details).

Compatibility

616 GSR

Installation Tips



Install the stones after the firebacks are in place.

Packing List

- 30-Piece Stone Set:



- Rear Light Deflector:



- (4) 10-24 Nuts
- Bag of Rock Wool
- Bag of Embers

- Rear Air Deflector:



- Rear Stone Grid Assembly, 2x Stone Index, 2x screws:



- Middle Left, Middle Right, Front Left, Front Right Stone Grids:



Burner Installation

NOTE: The insert should be in place, with the gas line and vent attached and the firebacks installed (see the owner's manual for further details).

NOTE: Graphical illustrations are provided with photos in these installation instructions.

1. Remove the rear burner as shown below.



NOTE: Remove the attachment screw first.

2. Remove the four screws securing the two individual light covers to the firebox. Discard the light covers (retain the screws).

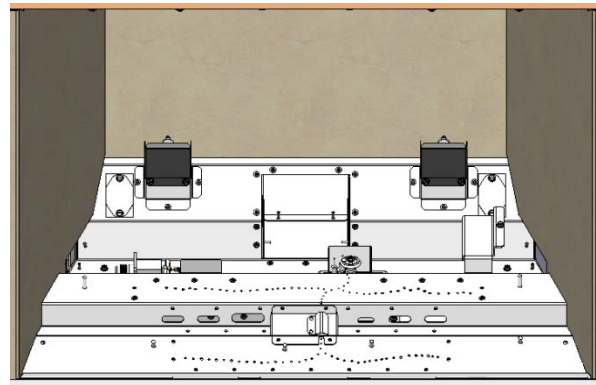
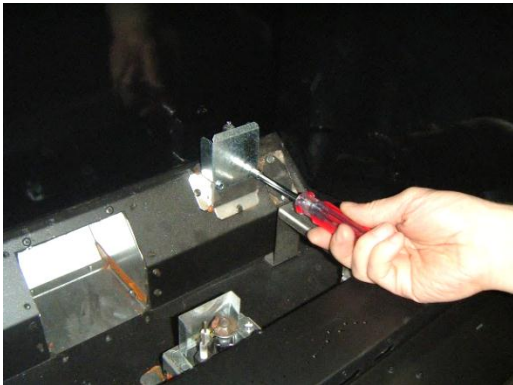

3. Install the rear light deflector using the screws removed in the previous step.

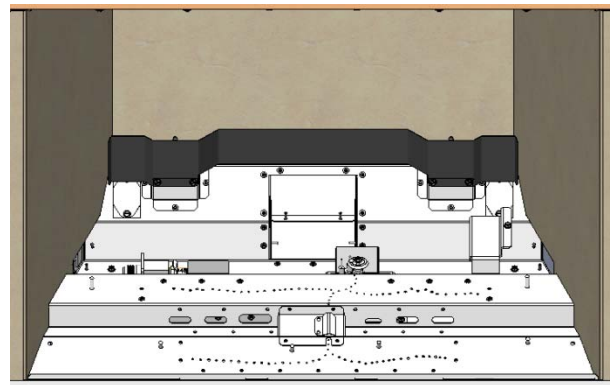

616 GSR Stone Set "D" Installation Instructions (SKU 94700728)

4. Remove the 3 screws from the back of the rear burner using a ¼" nutdriver.

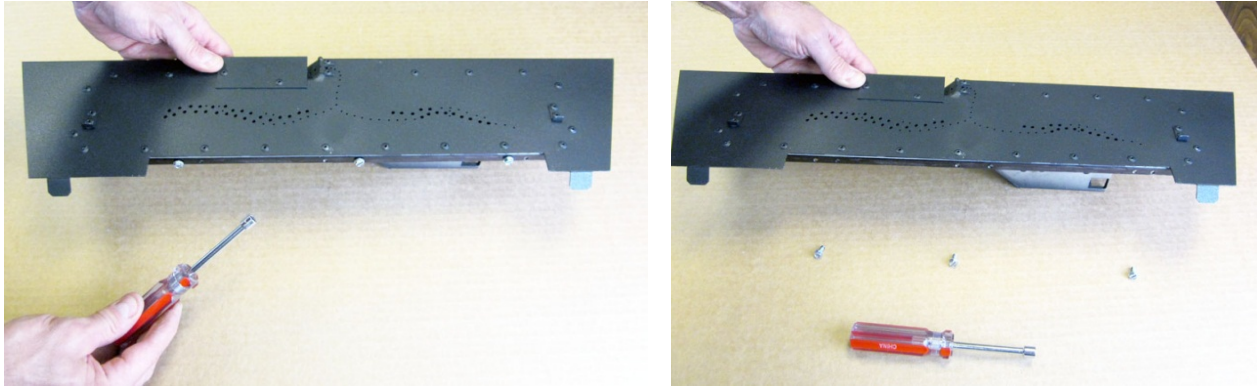

5. Attach the rear air deflector to the rear burner with the screws removed in the previous step.

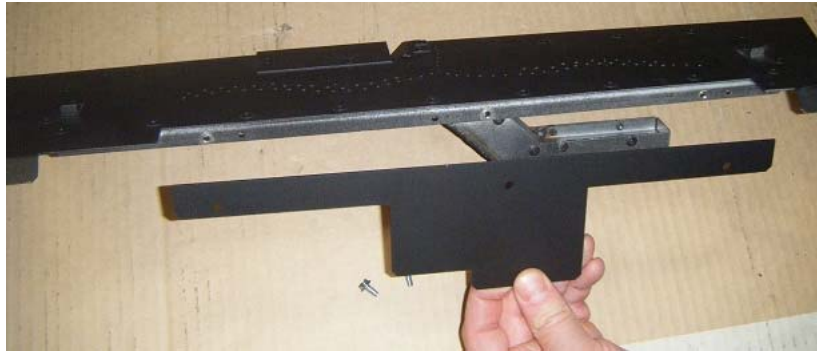

6. Replace the rear burner and secure with the attachment screw.

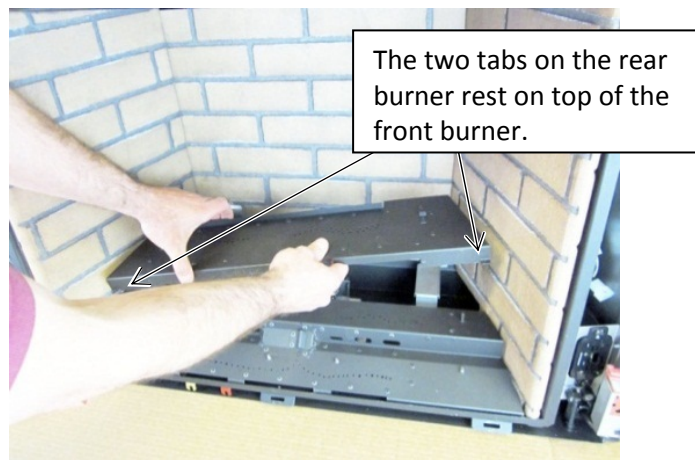

616 GSR Stone Set “D” Installation Instructions (SKU 94700728)

7. Bend all stone grid tabs to a 90° position with a pair of pliers.
8. Attach the two stone index brackets to the rear stone grid assembly, using the screws provided.

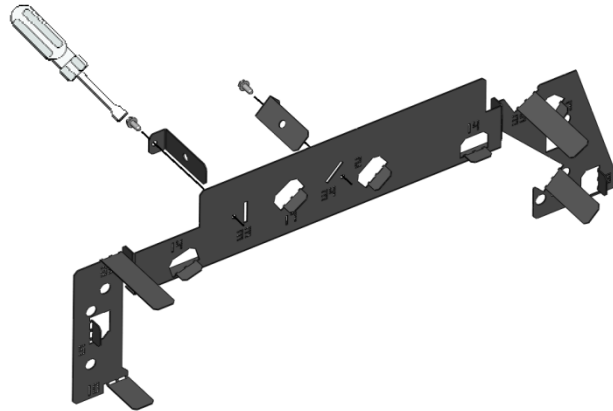

9. Install the rear stone grid assembly by sliding it under the rear light deflector. The grid assembly should rest over the two burner tabs as shown below.

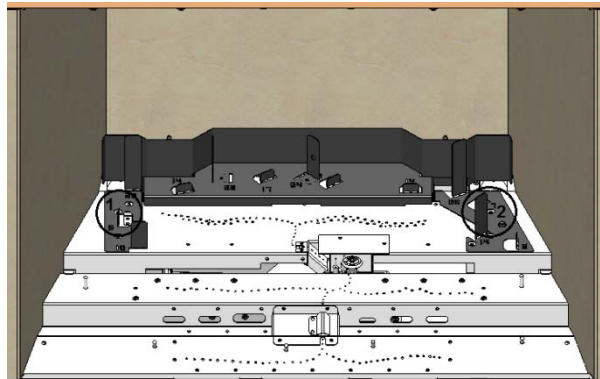

10. Install the center left stone grid plate using a 10-24 nut. Keep the grid plate tight against the rear burner's front edge.

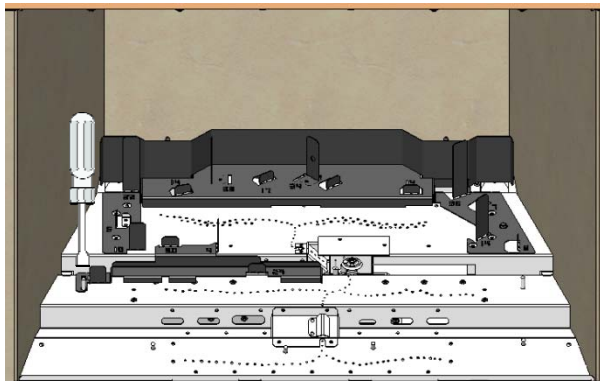

616 GSR Stone Set “D” Installation Instructions (SKU 94700728)

11. Install the center right stone grid plate using a 10-24 nut. Keep the grid plate tight against the rear burner’s front edge.

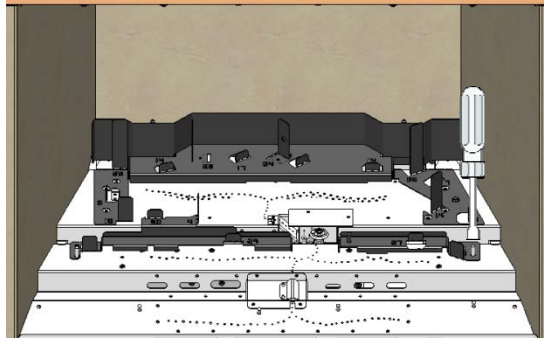

12. Install the front left stone grid plate using a 10-24 nut. Keep the grid plate tight against the front burner’s front edge.

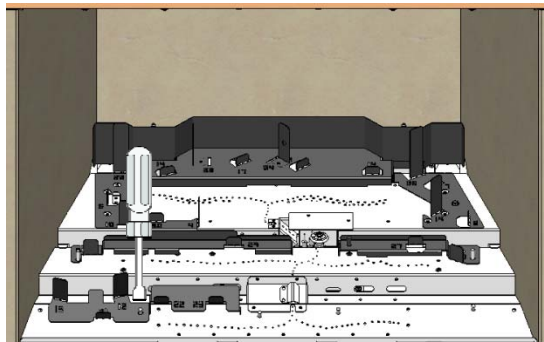

13. Install the front right stone grid plate using a 10-24 nut. Keep the grid plate tight against the front burner’s front edge.

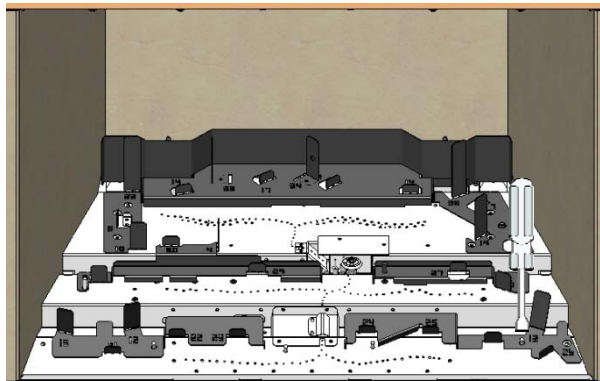

Stone Placement



Each stone has a slot and a number etched into it. The stones are placed onto the stone grid, matching the number on the stone to the number on the grid.

EXAMPLE: Stone marked "5" is inserted over the tab marked "5" on the stone grid.

NOTE: The numbers on the grid are not in sequential order.



NOTE: Numbers on the stones should always face the rear or side of the firebox.



NOTE: There are (2) each of stones numbered 10 and 13.

1. Place the base stones onto the grid tabs first, in the following order:

Rear Row Stones: #5, 14, 17, 2, 14, 7, 8

Middle Row Stones: #31, 30, 29, 28, 27

Front Row Stones: #21, 22, 23, 24, 25, 26



- Place the remaining stacked stones onto the grid tabs. These include:

Stacked Stones: #32, 33, 34, 35, 10, 4, 19, 16, 13, 12, 13

NOTE: There is no number on the stone grid for stone #16, it is a free-standing stone.



Rock Wool Placement

- Place the rock wool as follows:
 - Brush the rock wool using a stiff brush in a loose, gauze-like layer.



TIP: Hold the rock wool in a tight wad with one hand while brushing with the other.



The rock wool should be approximately 1/8" thick over the burner ports.

Ember Chunks Placement

1. Place ember chunks across the front of the burner in a single-file line.



2. Ember chunks may be placed on the stone grids between the stones to hide the grids, as well as in corners and against the burner’s outer edges.



3. Re-apply the rock wool over the ember chunks along the front burner and between the two front stones for a natural look.

TIP: Natural gas (NG) can use more rock wool than propane (LP).

TIP: Applying a generous amount of rock wool results in a darker flame and a brighter coal bed.

NOTE: Initial application of rock wool may cause “matting” over burner ports. Turning the unit on and then off again will loosen the rock wool, resulting in a better flame.

4. The insert should be test-burned with the glass frame in place before finishing the installation. See the owner’s manual for details on finalizing the installation (adjusting the air shutter, etc.).

616 GSR Stone Set “D” Installation Instructions (SKU 94700728)

Completed stone set installation:

